

EC Motor 62x87
1.25.058.0XX

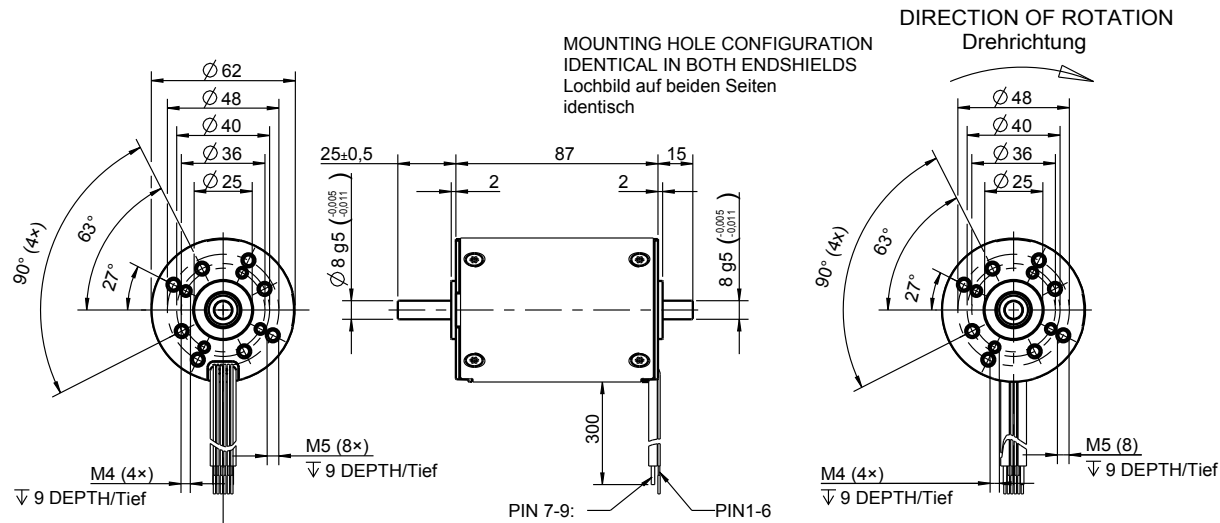

CABLE IDENTIFICATION / Kabel Zuordnung			
NR.	SIZE/Größe	COLOUR/Farbe	FUNCTION/Funktion
1	28 AWG	BROWN/braun	SUPPLY +ve
2	28 AWG	RED/rot	SUPPLY -ve
3	28 AWG	ORANGE/orange	--
4	28 AWG	YELLOW/gelb	HALL EFFECT 3
5	28 AWG	GREEN/grün	HALL EFFECT 1
6	28 AWG	BLUE/blau	HALL EFFECT 2
7	16 AWG	BLACK/schwarz	PHASE C
8	16 AWG	WHITE/weiß	PHASE B
9	16 AWG	RED/rot	PHASE A

